

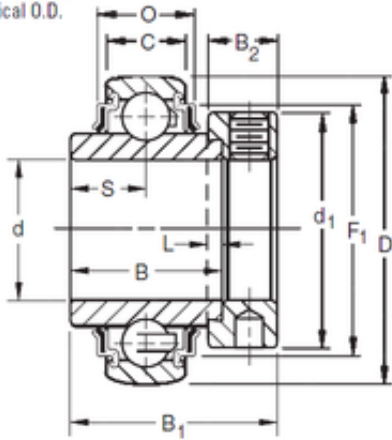

KRRB Two Seals  
Spherical O.D.



Bearing 2D drawings and 3D CAD models

Komatsu Monitoring panel 428-54-13620  
Monitoring panel Komatsu Monitoring panel  
Original import

Bearing No.

Size	57.15x110x61.91 mm
Bore Diameter	57,15 mm
Outer Diameter	110 mm
Width	61,91 mm
d	57,15 mm
D	110 mm
B	61,91 mm
C	22 mm
P	26,01 mm
O	30,02 mm
d1	84,1 mm
B1	77,8 mm
B2	22,2 mm
L	6,4 mm
S	31 mm
F1	94,89 mm
Weight	1,715 Kg
Basic dynamic load rating (C)	58,5 kN